

No. 3, 12th Alley
Hasan-e-Seyf St.
IRN Teheran
Tel. +98-21-88 57 40 27
www.nextoffice.ir

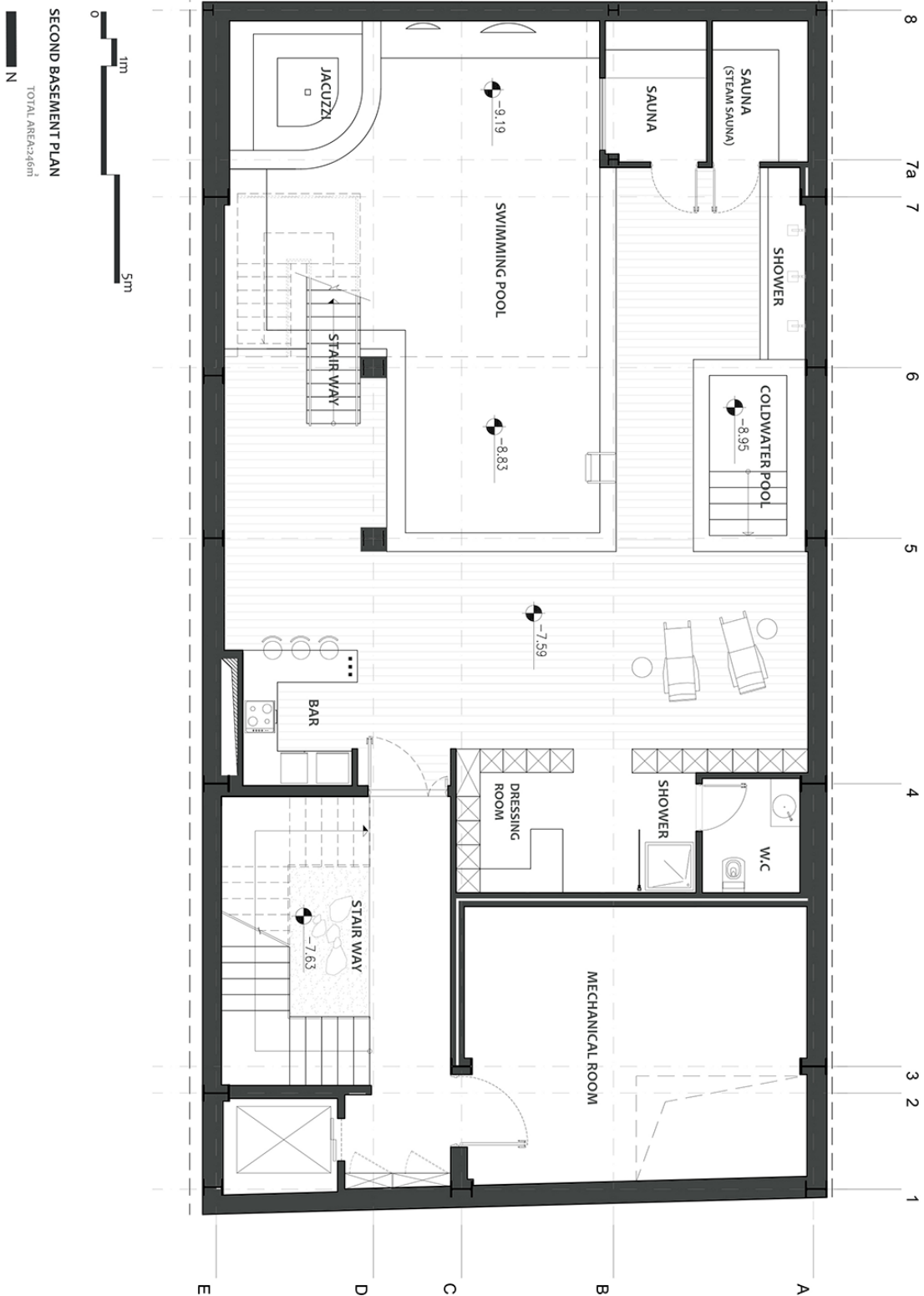

No. 3, 12th Alley
Hasan-e-Seyf St.
IRN Teheran
Tel. +98-21-88 57 40 27
www.nextoffice.ir

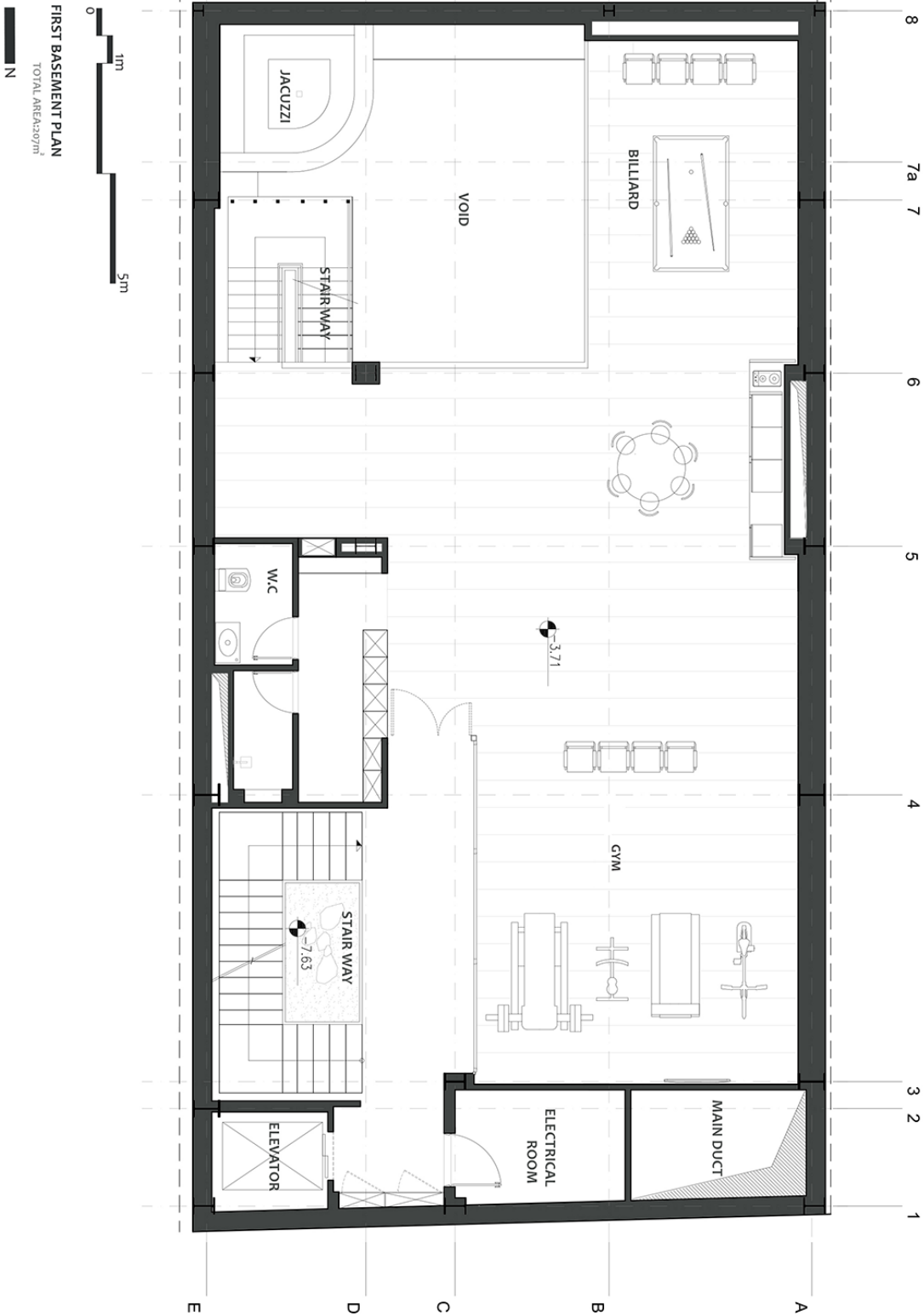

No. 3, 12th Alley
Hasan-e-Seyf St.
IRN Teheran
Tel. +98-21-88 57 40 27
www.nextoffice.ir

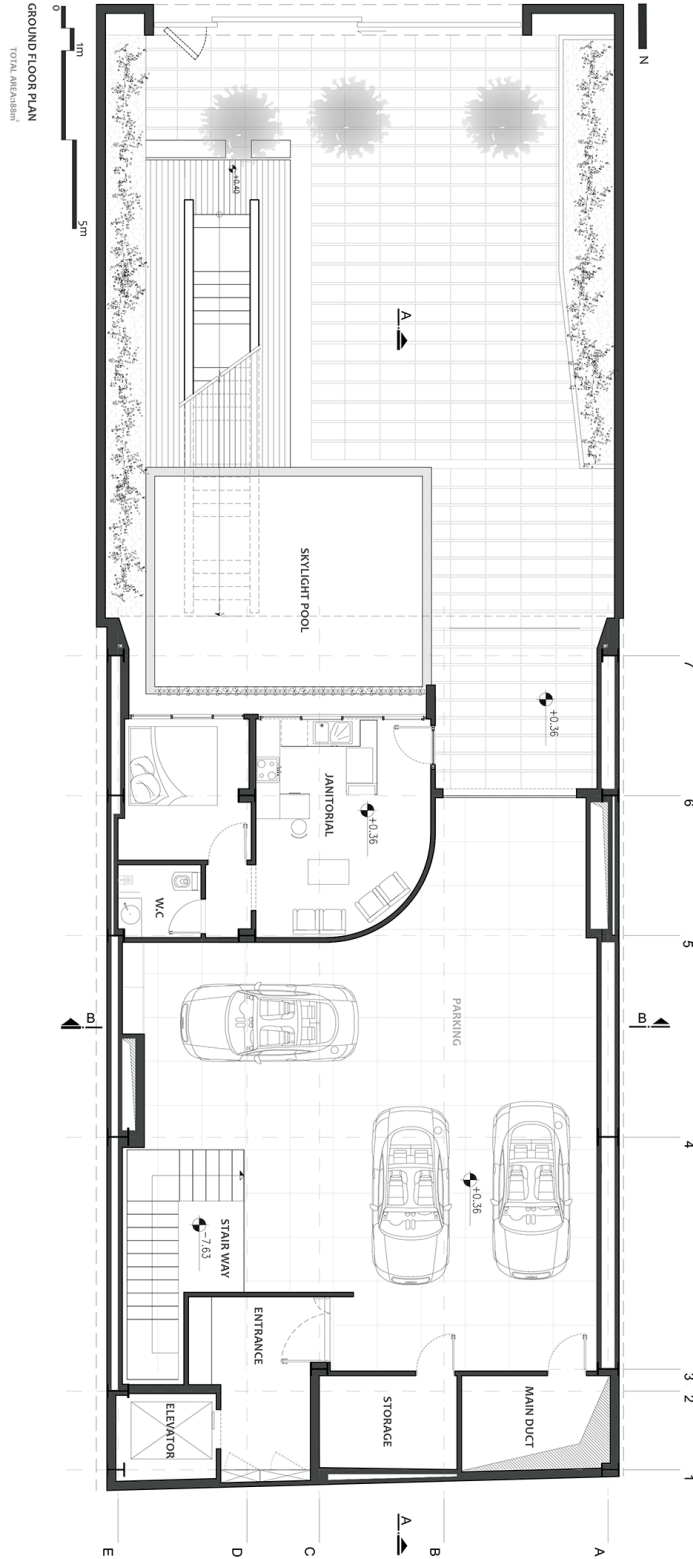

No. 3, 12th Alley
Hasan-e-Seyf St.
IRN Teheran
Tel. +98-21-88 57 40 27
www.nextoffice.ir

PLANS

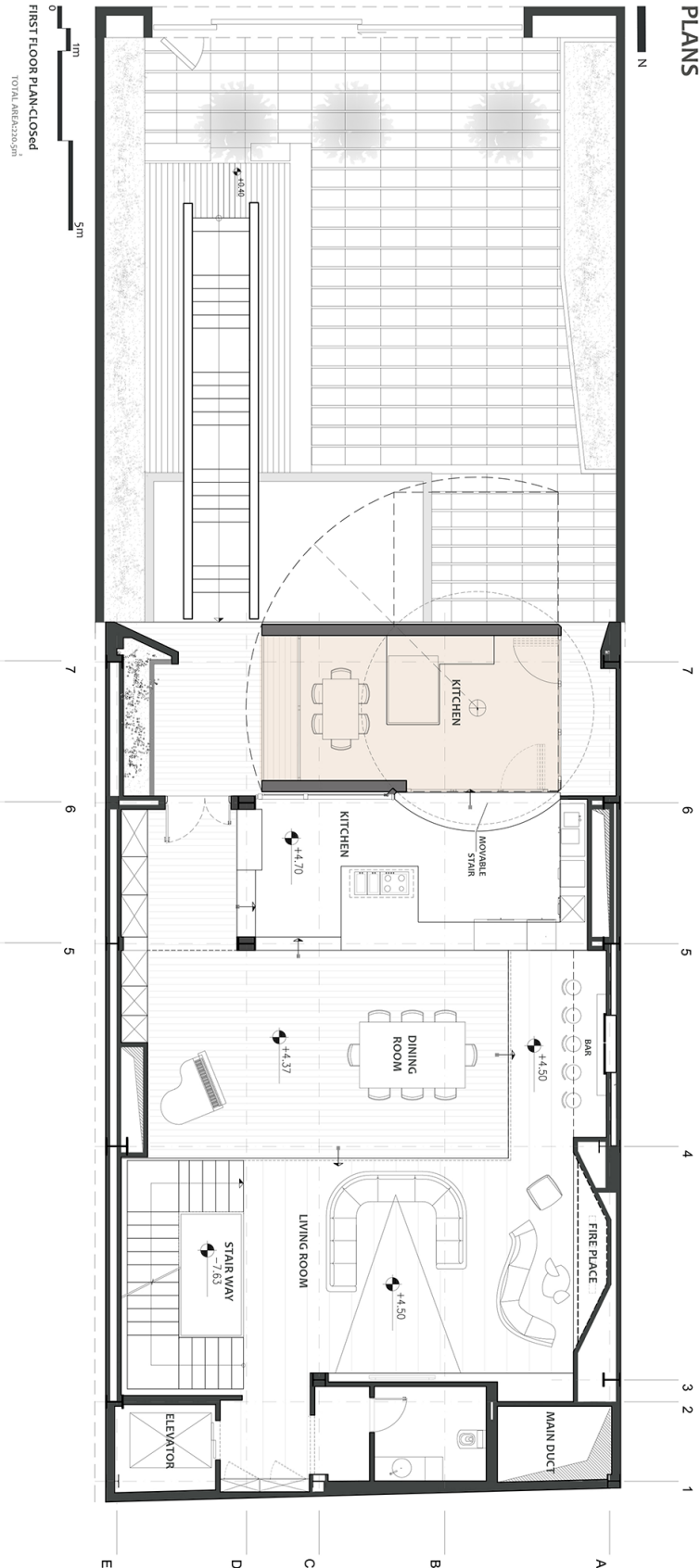

FIRST FLOOR PLAN-CLOSED
TOTAL AREA: 200.9m²

OPEN BOX

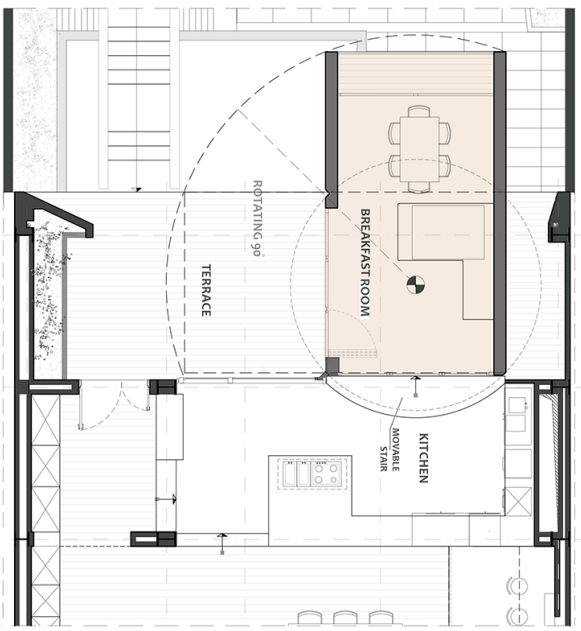

No. 3, 12th Alley
Hasan-e-Seyf St.
IRN Teheran
Tel. +98-21-88 57 40 27
www.nextoffice.ir

PLANS

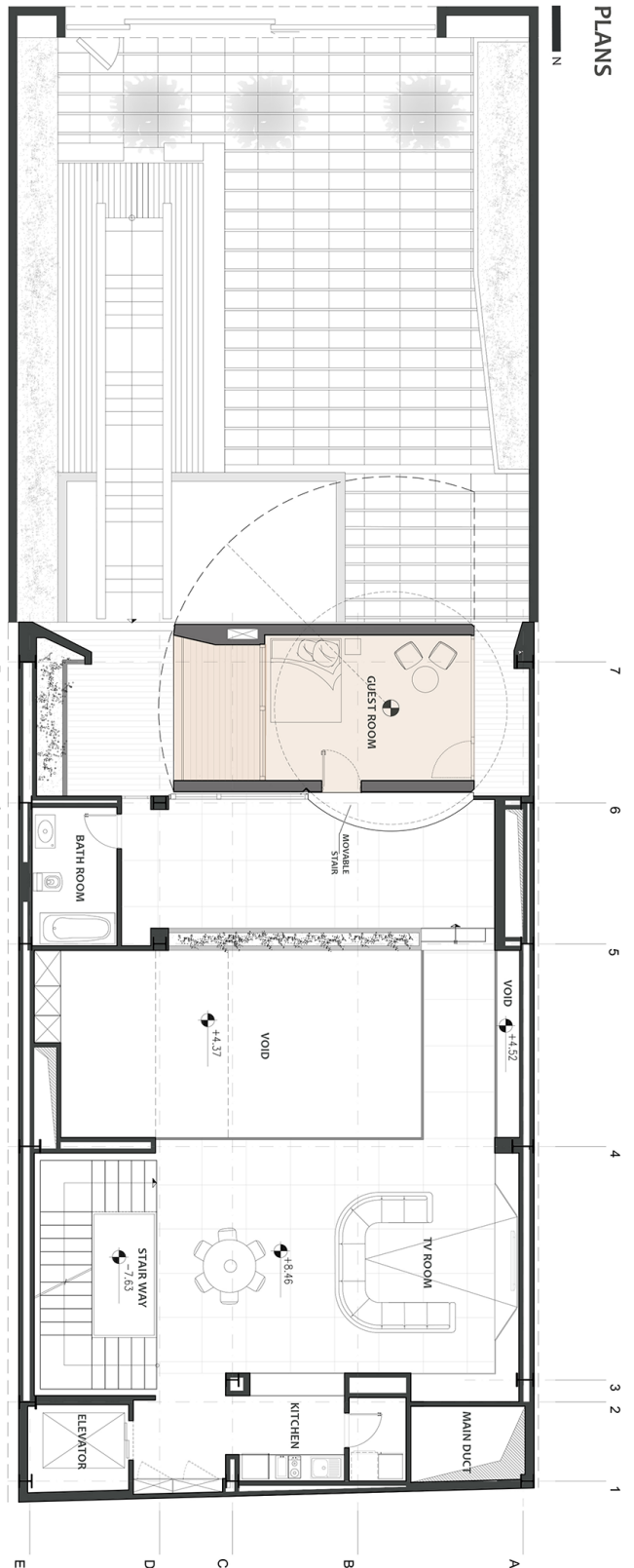

SECOND FLOOR PLAN
TOTAL AREA: 100.00 M²
OPEN BOX

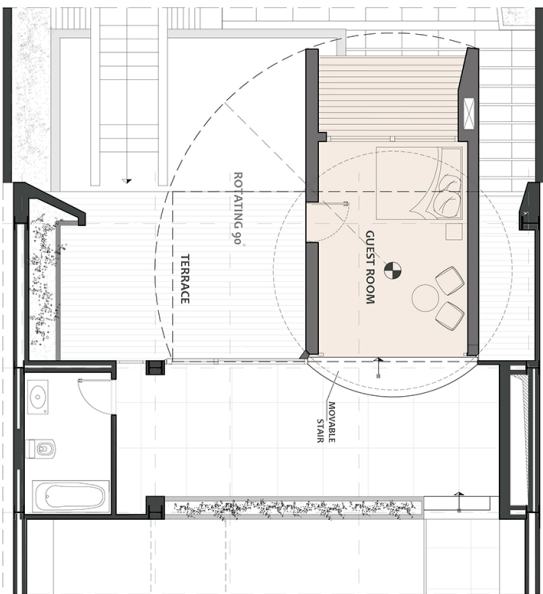

No. 3, 12th Alley
Hasan-e-Seyf St.
IRN Teheran
Tel. +98-21-88 57 40 27
www.nextoffice.ir



No. 3, 12th Alley
Hasan-e-Seyf St.
IRN Teheran
Tel. +98-21-88 57 40 27
www.nextoffice.ir

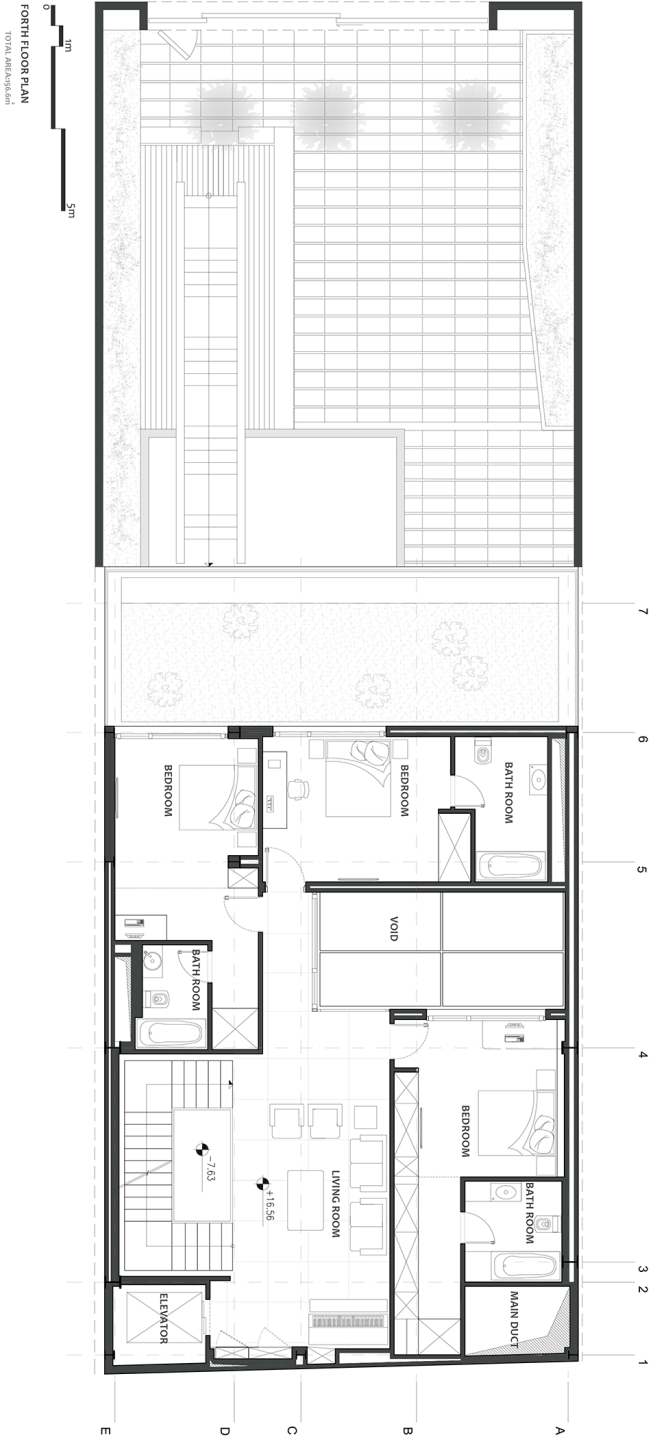

No. 3, 12th Alley
Hasan-e-Seyf St.
IRN Teheran
Tel. +98-21-88 57 40 27
www.nextoffice.ir



SECTION A-A
SC:1/300

No. 3, 12th Alley
Hasan-e-Seyf St.
IRN Teheran
Tel. +98-21-88 57 40 27
www.nextoffice.ir



SECTION B-B

SC:1/300

No. 3, 12th Alley
 Hasan-e-Seyf St.
 IRN Teheran
 Tel. +98-21-88 57 40 27
 www.nextoffice.ir

MAIN CONCEPT

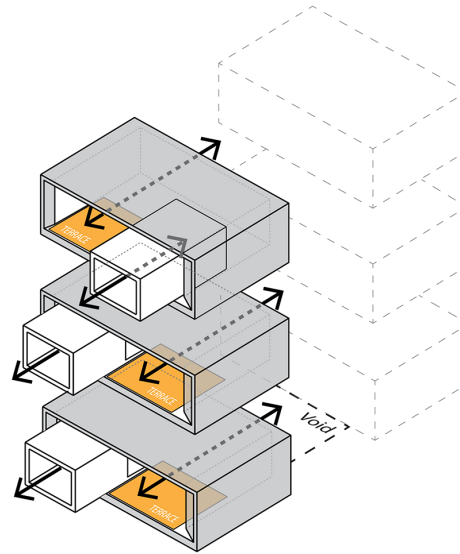
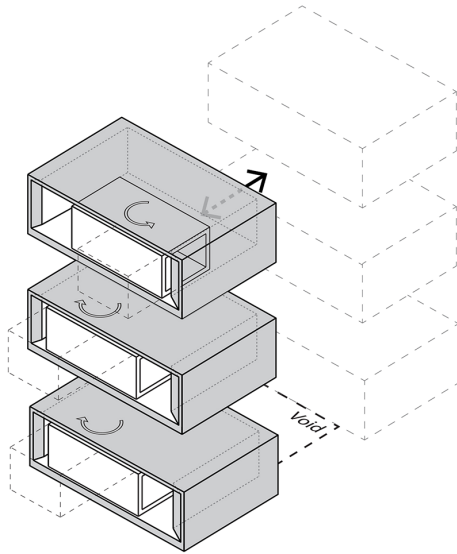
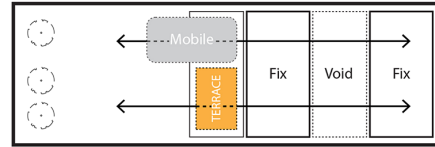
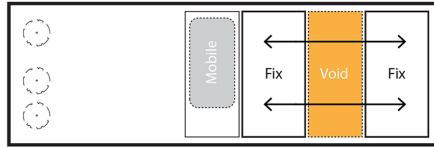

ROTATION PROCESS

FIRST FLOOR

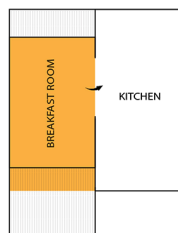
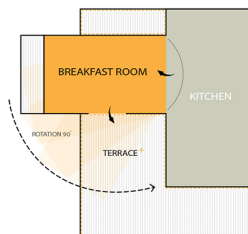

SECOND FLOOR

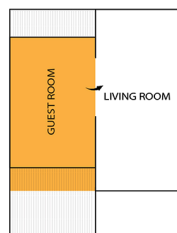
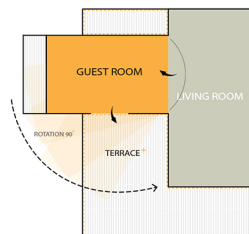

THIRD FLOOR

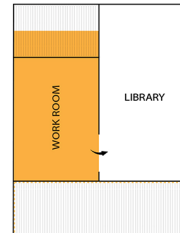
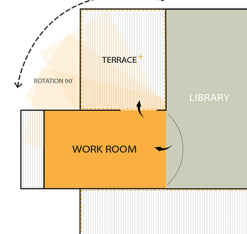

ROTATION OF THE BOX,
 MAKES THE TERRACE
 LARGER

No. 3, 12th Alley
Hasan-e-Seyf St.
IRN Teheran
Tel. +98-21-88 57 40 27
www.nextoffice.ir

SECTION DIAGRAM

